





# IBPS RRB 2021



4 घंटे लगातार

# महा मैराथन

25 जुलाई

• **LIVE**

**Reasoning / Quantitative Aptitude**



# UPCOMING ONLINE BATCHES

## JULY 2021

07 July 2021

08:00 AM to 10:00 AM

**LIVE PREMIUM  
GREEN CARD**  
(BANK-PO & CLERK)

BILINGUAL

14 July 2021

10:30 AM to 12:30 PM

**LIVE PREMIUM SILVER CARD**  
(CGL & CHSL)

03:00 PM to 05:00 PM

**LIVE PREMIUM STATE CARD**  
(UPSSSC PET)

10:30 AM to 02:00 PM

**IBPS CLERK PRELIMS 2021**  
(CRASH COURSE)

BILINGUAL

21 July 2021

01:00 PM to 03:00 PM

**LIVE PREMIUM GREEN CARD**  
(IBPS RRB PO/CLERK PRE + MAINS)

06:30 PM to 09:30 PM

**IBPS CLERK PRELIMS 2021**  
(CRASH COURSE)

BILINGUAL

28 July 2021

01:00 PM to 03:00 PM

**LIVE PREMIUM BRONZE CARD**  
(TET)

07:30 PM to 09:30 PM

**LIVE PREMIUM GREEN CARD**  
(IBPS PO & CLERK)

08:00 AM to 10:00 AM

**LIVE PREMIUM SILVER CARD**  
(SSC CGL & CHSL)

08:00 AM to 11:30 AM

**IBPS CLERK PRELIMS 2021**  
(CRASH COURSE)

BILINGUAL







# **IBPS Clerk Prelims 2021**

**Crash Course**

**Batch Starts July 28, 2021**

**08:00 AM To 11:30 AM**

**LIVE CLASS**



**Bilingual**

Eight persons A, B, C, D, E, F, G and H have their birthdays on different months of the year viz. January, April, May and July, such that not more than two persons have their birthdays in the same months. All the birthdays are either on 14th or 23rd of the month. No two persons have their birthdays on the same day of the same month. The following information is also known about them. F does not have birthday in May. E wasn't born in July. H's birthday is immediately after B's. E celebrates his birthday before B.

The number of persons who have their birthdays between the birthdays of G and H is equal to the number of persons who have their birthdays between the birthdays of B and D. D was born in July. Birthdays of both E and B are in the same month. There are three birthdays between the birthdays of F and C. G celebrates his birthday before B.

आठ व्यक्ति A, B, C, D, E, F, G और H का जन्मदिन साल के अलग-अलग महीनों में होता है। जनवरी, अप्रैल, मई और जुलाई, जैसे कि एक ही महीने में दो से अधिक व्यक्तियों के जन्मदिन नहीं होते हैं। सभी जन्मदिन या तो महीने की 14 या 23 तारीख को होते हैं। एक ही महीने के एक ही दिन दो व्यक्तियों का जन्मदिन नहीं होता है। उनके बारे में निम्न जानकारी भी ज्ञात है। F का जन्मदिन मई में नहीं है। E का जन्म जुलाई में नहीं हुआ था। H का जन्मदिन B के ठीक बाद है। E अपना जन्मदिन B से पहले मनाता है। G और H के जन्मदिनों के बीच जिन व्यक्तियों का जन्मदिन है, उनकी संख्या B और D के जन्मदिनों के बीच जन्मदिन मनाने वाले व्यक्तियों की संख्या के बराबर है। D का जन्म जुलाई में हुआ था। E और B दोनों का जन्मदिन एक ही महीने में है। F और C के जन्मदिनों के बीच तीन जन्मदिन हैं। G अपना जन्मदिन B से पहले मनाता है।



Eight persons A, B, C, D, E, F, G and H have their birthdays on different months of the year viz. January, April, May and July, such that not more than two persons have their birthdays in the same months. All the birthdays are either on 14th or 23rd of the month. No two persons have their birthdays on the same day of the same month. The following information is also known about them. F does not have birthday in May. E wasn't born in July. H's birthday is immediately after B's. E celebrates his birthday before B. The number of persons who have their birthdays between the birthdays of G and H is equal to the number of persons who have their birthdays between the birthdays of B and D. D was born in July. Birthdays of both E and B are in the same month. There are three birthdays between the birthdays of F and C. G celebrates his birthday before B

Who among the following were born in the same month?

निम्नलिखित में से कौन एक ही महीने में पैदा हुए थे?

- A A and D
- B B and C
- C C and F
- D D and G
- E None of these

30

Month	Day	Person
January	14 <sup>th</sup>	G
January	23 <sup>rd</sup>	F
April	14 <sup>th</sup>	E
April	23 <sup>rd</sup>	B
May	14 <sup>th</sup>	H
May	23 <sup>rd</sup>	C
July	14 <sup>th</sup>	A
July	23 <sup>rd</sup>	D

Who was born on 23<sup>rd</sup> July?

23 जुलाई को किसका जन्म हुआ था?

A A

B B

C C

D D

E None of these

30

Month	Day	Person
January	14 <sup>th</sup>	G
January	23 <sup>rd</sup>	F
April	14 <sup>th</sup>	E
April	23 <sup>rd</sup>	B
May	14 <sup>th</sup>	H
May	23 <sup>rd</sup>	C
July	14 <sup>th</sup>	A
July	23 <sup>rd</sup>	D



Which of the following Birthday – Person combination is correct?

निम्नलिखित में से कौन सा जन्मदिन-व्यक्ति संयोजन सही है?

A January 23<sup>rd</sup> – G

B April 14<sup>th</sup> – E

C May 23<sup>rd</sup> – H

D July 14<sup>th</sup> – C

E None of these



Month	Day	Person
January	14 <sup>th</sup>	G
January	23 <sup>rd</sup>	F
April	14 <sup>th</sup>	E
April	23 <sup>rd</sup>	B
May	14 <sup>th</sup>	H
May	23 <sup>rd</sup>	C
July	14 <sup>th</sup>	A
July	23 <sup>rd</sup>	D

How many pairs of letters are there in the word "INVENTORY" each of which has as many letters between them in the word as in the English alphabetical series?

शब्द "INVENTORY" में अक्षरों के ऐसे कितने जोड़े हैं, जिनमें से प्रत्येक के बीच उतने ही अक्षर हैं जितने कि अंग्रेजी वर्णमाला श्रृंखला में हैं?

- A. One
- B. Two
- C. Four
- D. None
- E. Three

30

Ten persons are sitting in two parallel rows and facing each other. In row1: A, B, C, D, and E are sitting and facing south. In row2: P, Q, R, S and T are sitting and facing north.

C sits at either the right end or left end. Only one person sits between C and the one who sits opposite to T. D sits second to the right of E and none of them sits at the extreme end. B and Q are sitting opposite to each other. Q and S are immediate neighbours. R sits diagonally opposite to the one who sits immediate right of D.

दस व्यक्ति दो समानांतर पंक्तियों में बैठे हैं और एक दूसरे का सामना कर रहे हैं। पंक्ति1 में: A, B, C, D और E दक्षिण की ओर मुख करके बैठे हैं। पंक्ति 2 में: P, Q, R, S और T बैठे हैं और उत्तर की ओर उन्मुख हैं।

C या तो दायें छोर पर या बायें छोर पर बैठा है। C और T के विपरीत बैठे व्यक्ति के बीच केवल एक व्यक्ति बैठा है। D, E के दायें से दूसरे स्थान पर बैठा है और उनमें से कोई भी अंतिम छोर पर नहीं बैठा है। B और Q एक दूसरे के विपरीत बैठे हैं। Q और S निकटतम पड़ोसी हैं। R उस व्यक्ति के तिरछे विपरीत बैठा है जो D के ठीक दायें बैठा है।



**Ten persons are sitting in two parallel rows and facing each other. In row1: A, B, C, D, and E are sitting and facing south. In row2: P, Q, R, S and T are sitting and facing north.**

**C sits at either the right end or left end. Only one person sits between C and the one who sits opposite to T. D sits second to the right of E and none of them sits at the extreme end. B and Q are sitting opposite to each other. Q and S are immediate neighbours. R sits diagonally opposite to the one who sits immediate right of D.**



**Who among the following person sits third to the left of the one who sits opposite to E?**

- a) The one who sits second to the right of Q
- b) The one who sits immediate left of S
- c) The one who sits third from the extreme right end
- d) R
- e) None of the above

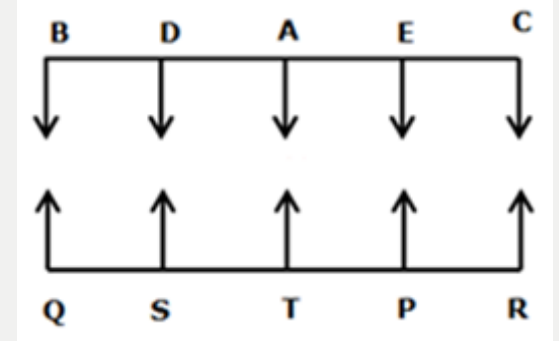

निम्नलिखित में से कौन E के विपरीत बैठे व्यक्ति के बाएं से तीसरे स्थान पर बैठा है?

- a) वह व्यक्ति जो Q के दायें से दूसरे स्थान पर बैठा है
- b) वह व्यक्ति जो S के ठीक बायें बैठा है
- c) वह व्यक्ति जो अंतिम दायें छोर से तीसरे स्थान पर बैठा है
- d) आर
- e) उपरोक्त में से कोई नहीं



Who among the following person(s) sits left of D?

- I) The one who sits second to the left of B.
- II) E
- III) C

निम्नलिखित में से कौन D के बायें बैठा है?

- I) वह जो B के बाएं से दूसरे स्थान पर बैठा है।
- II) ई
- III) सी

- a) Only (II) and (III)
- b) Only (I)
- c) Only (I) and (III)
- d) Only (II)
- e) All (I), (II) and (III)

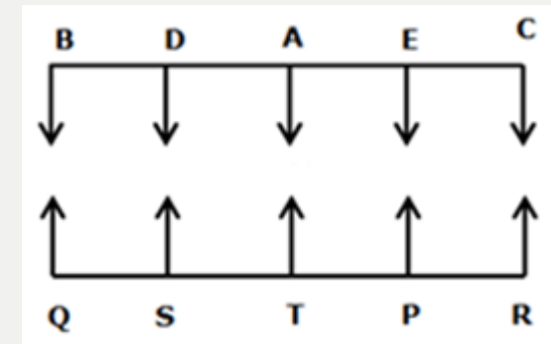

If one of the immediate neighbours of T is S, then who is the second one?

- a) The one who sits opposite C
- b) Q
- c) The one who sits immediate left of S
- d) P
- e) No one

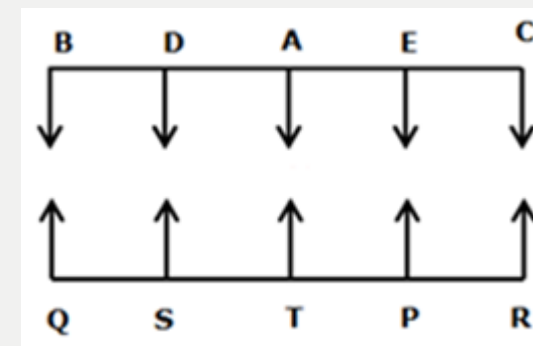

यदि T के निकटतम पड़ोसियों में से एक S है, तो दूसरा कौन है?

- a) वह व्यक्ति जो C के विपरीत बैठा है
- b) क्यू
- c) वह व्यक्ति जो S के ठीक बायें बैठा है
- d) पी
- e) कोई नहीं



Four among the following five are similar in such a way to form a group, who among the following one doesn't belong to the group?

निम्नलिखित पांच में से चार एक समूह बनाने के लिए समान हैं, निम्नलिखित में से कौन समूह से संबंधित नहीं है?

- a) The one who sits second to the right of A
- b) C
- c) The one who sits opposite to T
- d) Q
- e) R

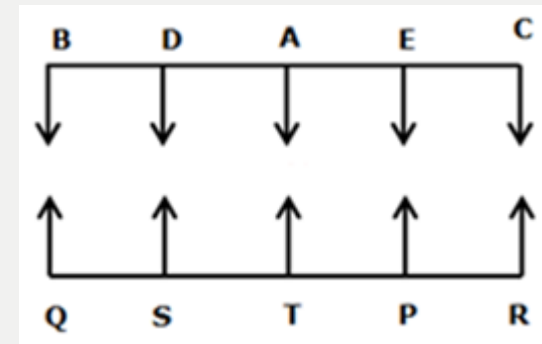



In a certain way, Q is related to D and S is related to A in the same way who among the following person is related to C?

एक निश्चित तरीके से, Q, D से संबंधित है और S, A से संबंधित है, उसी प्रकार निम्नलिखित में से कौन सा व्यक्ति C से संबंधित है?

- a) The one who immediate left of Q
- b) R
- c) T
- d) P
- e) None

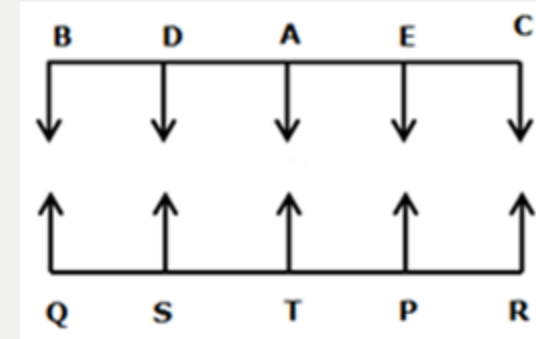

Study the following information carefully and answer the below questions.

Each letter of the word is written under column-I has been coded as a digit and given under column-II

शब्द के प्रत्येक अक्षर को कॉलम-I के तहत लिखा गया है और एक अंक के रूप में कोडित किया गया है और कॉलम-II के तहत दिया गया है

Column I	Column II
AFFECT	735276
ASSET	93956
BETTER	156465

What is the code for the letters 'F C' in the given code language?

- a) 6 7
- b) 5 2
- c) 7 2
- d) Either b or c
- e) Can't be determined



Study the following information carefully and answer the below questions.

Each letter of the word is written under column-I has been coded as a digit and given under column-II

शब्द के प्रत्येक अक्षर को कॉलम-I के तहत लिखा गया है और एक अंक के रूप में कोडित किया गया है और कॉलम-II के तहत दिया गया है

Column I	Column II
AFFECT	735276
ASSET	93956
BETTER	156465



What does “6” represent in the given code language?

- a) T
- b) E
- c) A
- d) B
- e) Either (a) or (b)

Letters	Codes	Letters	Codes
R/B	4/1	A	3
F	7	E/T	5/6
C	2	S	9

Study the following information carefully and answer the below questions.

Each letter of the word is written under column-I has been coded as a digit and given under column-II

शब्द के प्रत्येक अक्षर को कॉलम-I के तहत लिखा गया है और एक अंक के रूप में कोडित किया गया है और कॉलम-II के तहत दिया गया है

Column I	Column II
AFFECT	735276
ASSET	93956
BETTER	156465



If "R F" represents a code "4 7" then what does "1 9 2" represent in a code language?

- a) S B T
- b) C B A
- c) B S C
- d) S E C
- e) None of the above

Letters	Codes	Letters	Codes
R/B	4/1	A	3
F	7	E/T	5/6
C	2	S	9



If all the letters of the word **CINEMATIC** are arranged in alphabetical order from right to left, then which of the following is the 3<sup>rd</sup> letter to the left of 2<sup>nd</sup> vowel from the right end?

यदि शब्द **CINEMATIC** के सभी अक्षरों को दाएँ से बाएँ वर्णानुक्रम में व्यवस्थित किया जाता है, तो निम्नलिखित में से दाएँ छोर से दूसरे स्वर के बाएँ से तीसरा वर्ण कौन सा है?

- A.M
- B.N
- C.I
- D.E
- E.C



If in the number 271935468, the digits at the odd position are increased by 1 and the digits at the even position are decreased by 2, then how many digits thus formed are greater than six?

यदि संख्या में 271935468, विषम स्थिति के अंकों में १ से वृद्धि की जाती है और सम स्थिति के अंकों में २ से कमी की जाती है, तो इस प्रकार बने कितने अंक छह से बड़े होंगे?

- A.2
- B.3
- C.4
- D.1
- E. More than four

30

Eight persons viz. P, Q, R, S, T, U, V and W are living in an eight storey building, but not necessarily in the same order. The lowermost floor is numbered 1 and the floor immediately above is numbered 2 and so on. Not more than one person lives on the same floor.

Q lives on an odd numbered floor below the sixth floor but not on the bottommost floor. Only two persons live between Q and P, who lives above Q. The number of floors between Q and P is one more than the number of floors between Q and S who doesn't live adjacent to P. There is only one person living between P and T who lives immediately below V. Not more than two persons live between U and R who lives immediately below W.

आठ व्यक्ति अर्थात् P, Q, R, S, T, U, V और W एक आठ मंजिला इमारत में रहते हैं, लेकिन जरूरी नहीं कि इसी क्रम में हों। सबसे निचली मंजिल की संख्या 1 है और ठीक ऊपर की मंजिल की संख्या 2 है और इसी तरह आगे भी। एक ही मंजिल पर एक से अधिक व्यक्ति नहीं रहते हैं।

Q छठी मंजिल के नीचे एक विषम संख्या वाली मंजिल पर रहता है लेकिन सबसे निचली मंजिल पर नहीं रहता है। Q और P के बीच केवल दो व्यक्ति रहते हैं, जो Q के ऊपर रहता है। Q और P के बीच मंजिलों की संख्या Q और S के बीच मंजिलों की संख्या से एक अधिक है जो P के आसन्न नहीं रहता है। केवल एक व्यक्ति के बीच रहता है P और T, जो V के ठीक नीचे रहते हैं। U और R के मध्य दो से अधिक व्यक्ति नहीं रहते हैं, जो W के ठीक नीचे रहता है।



**Eight persons viz. P, Q, R, S, T, U, V and W are living in an eight storey building, but not necessarily in the same order. The lowermost floor is numbered 1 and the floor immediately above is numbered 2 and so on. Not more than one person lives on the same floor.**

**Q lives on an odd numbered floor below the sixth floor but not on the bottommost floor. Only two persons live between Q and P, who lives above Q. The number of floors between Q and P is one more than the number of floors between Q and S who doesn't live adjacent to P. There is only one person living between P and T who lives immediately below V. Not more than two persons live between U and R who lives immediately below W.**



Four of the following five are alike in a certain way and hence form a group.  
Find the one that doesn't belong to that group.

निम्नलिखित पांच में से चार एक निश्चित तरीके से समान हैं और इसलिए एक समूह बनाते हैं। वह खोजें जो उस समूह से संबंधित नहीं है।

A. W

B. T

C. U

D. P

E. V



Floor	Persons
8	P
7	V
6	T
5	Q
4	U
3	S
2	W
1	R

In which of the following floor does R live?  
निम्नलिखित में से किस मंजिल में R रहता है?

- A. 4th
- B. 5th
- C. 1st
- D. 7th
- E. 8th



Floor	Persons
8	P
7	V
6	T
5	Q
4	U
3	S
2	W
1	R

How many persons live between T and W?

T और W के मध्य कितने व्यक्ति रहते हैं?

- A. One
- B. Three
- C. Two
- D. More than three
- E. None

30

Floor	Persons
8	P
7	V
6	T
5	Q
4	U
3	S
2	W
1	R

If all the persons are arranged in alphabetical order from top to bottom, then how many persons remain unchanged in their positions?

यदि सभी व्यक्तियों को ऊपर से नीचे तक वर्णानुक्रम में व्यवस्थित किया जाता है, तो कितने व्यक्ति अपने स्थान पर अपरिवर्तित रहते हैं?

- A. One
- B. Two
- C. Three
- D. More than three
- E. None



Floor	Persons
8	P
7	V
6	T
5	Q
4	U
3	S
2	W
1	R

If P is related to T in the same way Q is related to S, then U is related to \_\_\_\_?  
यदि P, T से संबंधित है उसी प्रकार Q, S से संबंधित है, तो U \_\_\_\_\_ से संबंधित है?

- A.T
- B.Q
- C.S
- D.W
- E.R



Floor	Persons
8	P
7	V
6	T
5	Q
4	U
3	S
2	W
1	R

Ten persons P, Q, R, S, T, A, B, C, D and E are living in a five storey building such that ground floor is numbered as 1, above it is floor 2 then top floor is numbered as 5. Each of the floor has 2 flats in it as flat-1 and flat-2. Flat-1 of floor-2 is immediately above flat-1 of floor-1 and immediately below flat-1 of floor-3 and so on. In the same way flat-2 of floor-2 is immediately above flat-2 of floor-1 and immediately below flat-2 of floor-3 and so on. Flat-1 is in west of flat-2.

Q lives in an odd numbered floor. Both T and B lives in the same flat number. R and A live in the same floor. C does not live in flat number 2. There is a gap of two floors in which Q and P lives. Both P and Q do not live in the same flat number. T lives immediately above P in the same flat number. There is a gap of one floor in which T and B lives. E, who lives on an even numbered floor, lives below A and both lives in the same flat number. D lives above S and both live in the same flat number. C and S neither live in the same flat number nor in the same floor.

दस व्यक्ति P, Q, R, S, T, A, B, C, D और E एक पांच मंजिला इमारत में इस प्रकार रहते हैं कि भूतल की संख्या 1 है, इसके ऊपर मंजिल 2 है और शीर्ष मंजिल की संख्या 5 है। प्रत्येक मंजिल में फ्लैट -1 और फ्लैट -2 के रूप में 2 फ्लैट हैं। तल-2 का फ्लैट-1, तल-1 के फ्लैट-1 के ठीक ऊपर और तल-3 के फ्लैट-1 के ठीक नीचे है, इत्यादि। इसी प्रकार तल-2 का फ्लैट-2 तल-1 के फ्लैट-2 के ठीक ऊपर और तल-3 के फ्लैट-2 के ठीक नीचे है और इसी तरह आगे भी। फ्लैट-1, फ्लैट-2 के पश्चिम में है। Q एक विषम संख्या वाली मंजिल पर रहता है। T और B दोनों एक ही फ्लैट संख्या में रहते हैं। R और A एक ही मंजिल में रहते हैं। C फ्लैट संख्या 2 में नहीं रहता है। दो मंजिलों का अंतर है जिसमें Q और P रहता है। P और Q दोनों एक ही फ्लैट संख्या में नहीं रहते हैं। T समान फ्लैट संख्या में P के ठीक ऊपर रहता है। एक मंजिल का अंतर है जिसमें T और B रहते हैं। E, जो एक सम संख्या वाली मंजिल पर रहता है, A के नीचे रहता है और दोनों एक ही फ्लैट संख्या में रहते हैं। D, S के ऊपर रहता है और दोनों एक ही फ्लैट संख्या में रहते हैं। C और S न तो एक ही फ्लैट नंबर में रहते हैं और न ही एक ही मंजिल में।



Ten persons P, Q, R, S, T, A, B, C, D and E are living in a five storey building such that ground floor is numbered as 1, above it is floor 2 then top floor is numbered as 5. Each of the floor has 2 flats in it as flat-1 and flat-2. Flat-1 of floor-2 is immediately above flat-1 of floor-1 and immediately below flat-1 of floor-3 and so on. In the same way flat-2 of floor-2 is immediately above flat-2 of floor-1 and immediately below flat-2 of floor-3 and so on. Flat-1 is in west of flat-2.

Q lives in an odd numbered floor. Both T and B lives in the same flat number. R and A live in the same floor. C does not live in flat number 2. There is a gap of two floors in which Q and P lives. Both P and Q do not live in the same flat number. T lives immediately above P in the same flat number. There is a gap of one floor in which T and B lives. E, who lives on an even numbered floor, lives below A and both lives in the same flat number. D lives above S and both live in the same flat number. C and S neither live in the same flat number nor in the same floor.

Who among the following lives in flat-2 of 4th floor?

निम्नलिखित में से कौन चौथी मंजिल के फ्लैट-2 में रहता है?

- (a) R
- (b) A
- (c) P
- (d) E
- (e) None of these

30

Floor	Flat 1	Flat 2
5	C	Q
4	R	A
3	T	D
2	P	E
1	B	S

Who among the following lives with Q in the same floor?

निम्नलिखित में से कौन Q के साथ एक ही मंजिल पर रहता है?

- (a) C
- (b) B
- (c) E
- (d) D
- (e) None of these

30

Floor	Flat 1	Flat 2
5	C	Q
4	R	A
3	T	D
2	P	E
1	B	S

How many floors are there between C and R?

C और R के मध्य कितनी मंजिलें हैं?

- (a) One
- (b) Two
- (c) None
- (d) Three
- (e) Cannot be determined



Floor	Flat 1	Flat 2
5	C	Q
4	R	A
3	T	D
2	P	E
1	B	S

B lives on which of the following floor?

B निम्नलिखित में से किस मंजिल पर रहता है?

- (a) Floor-1
- (b) Floor-2
- (c) Floor-3
- (d) Floor-4
- (e) Floor-5



Floor	Flat 1	Flat 2
5	C	Q
4	R	A
3	T	D
2	P	E
1	B	S

Four of the following five are alike in a certain way and hence form a group, which among the following does not belong to that group?

निम्नलिखित पांच में से चार एक निश्चित तरीके से समान हैं और इसलिए एक समूह बनाते हैं, निम्नलिखित में से कौन उस समूह से संबंधित नहीं है?

- (a) A
- (b) E
- (c) S
- (d) D
- (e) T

Floor	Flat 1	Flat 2
5	C	Q
4	R	A
3	T	D
2	P	E
1	B	S





In each of the following questions, two rows of numbers are given. The resultant number in each row is to be worked out separately based on the following rules and the questions below the rows of numbers are to be answered. The operations of numbers progress from the left to the right.

**Rules:**

- (i) If a two-digit odd number is followed by a two-digit odd number, they are to be added.
- (ii) If a two-digit even number is followed by a two-digit odd number which is the perfect square, the even number is to be subtracted from the odd number
- (iii) If a three-digit number is followed by a two-digit number, then first number is to be divided by the second number.
- (iv) If a prime number is followed by an even number, the two are to be added.
- (v) If a two-digit even number is followed by another even number, the two are to be multiplied

I) 21 15 2

II) X 2 12

If X is the resultant of the first row, what is the resultant of the second row?

A.24

B.25

C.28

D.22

E.None of the Above

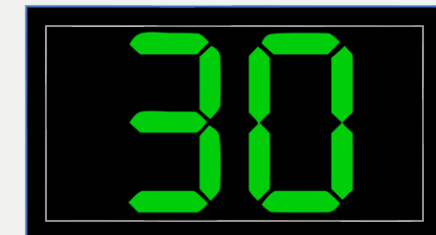

In each of the following questions, two rows of numbers are given. The resultant number in each row is to be worked out separately based on the following rules and the questions below the rows of numbers are to be answered. The operations of numbers progress from the left to the right.

**Rules:**

- (i) If a two-digit odd number is followed by a two-digit odd number, they are to be added.
- (ii) If a two-digit even number is followed by a two-digit odd number which is the perfect square, the even number is to be subtracted from the odd number
- (iii) If a three-digit number is followed by a two-digit number, then first number is to be divided by the second number.
- (iv) If a prime number is followed by an even number, the two are to be added.
- (v) If a two-digit even number is followed by another even number, the two are to be multiplied

I) 37 10 23

II) 18 49 12

What is the difference between the resultants of the two rows?

A.27

B.32

C.13

D.18

E.None of the Above

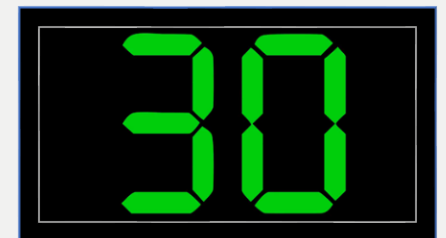
 30

In each of the following questions, two rows of numbers are given. The resultant number in each row is to be worked out separately based on the following rules and the questions below the rows of numbers are to be answered. The operations of numbers progress from the left to the right.

**Rules:**

- (i) If a two-digit odd number is followed by a two-digit odd number, they are to be added.
- (ii) If a two-digit even number is followed by a two-digit odd number which is the perfect square, the even number is to be subtracted from the odd number
- (iii) If a three-digit number is followed by a two-digit number, then first number is to be divided by the second number.
- (iv) If a prime number is followed by an even number, the two are to be added.
- (v) If a two-digit even number is followed by another even number, the two are to be multiplied

I) 18 8 12

II) 169 13  $X^2$

If X is the resultant of first row, what is the resultant of the second row?

- A.162
- B.178
- C.182
- D.157
- E.None of the Above

30

In each of the following questions, two rows of numbers are given. The resultant number in each row is to be worked out separately based on the following rules and the questions below the rows of numbers are to be answered. The operations of numbers progress from the left to the right.

**Rules:**

- (i) If a two-digit odd number is followed by a two-digit odd number, they are to be added.
- (ii) If a two-digit even number is followed by a two-digit odd number which is the perfect square, the even number is to be subtracted from the odd number
- (iii) If a three-digit number is followed by a two-digit number, then first number is to be divided by the second number.
- (iv) If a prime number is followed by an even number, the two are to be added.
- (v) If a two-digit even number is followed by another even number, the two are to be multiplied

I) 405 27 X

II) 35 19 81

If X is the resultant of second row, what is the resultant of the first row?

A.25

B.33

C.35

D.42

E.None of the Above



**Study the following information carefully and answer the below questions**

In a family there are six persons viz. F, J, G, K, M, and S and has two generations. K and M are brothers-in-laws. F is the only daughter of G. G and S are of same gender. F is the daughter-in-law of S who is not a parent of K. J is the mother of F. M does not have any siblings.

निम्नलिखित जानकारी का ध्यानपूर्वक अध्ययन करें और नीचे दिए गए प्रश्नों के उत्तर दें  
एक परिवार में छह व्यक्ति हैं अर्थात् एफ, जे, जी, के, एम, और एस और इसकी दो पीढ़ियां हैं। K और M ब्रदर-इन-लॉ हैं। F, G की इकलौती पुत्री है। G और S समान लिंग के हैं। F, S की बहू है, जो K का माता-पिता नहीं है। J, F की मां है। M का कोई भाई-बहन नहीं है।

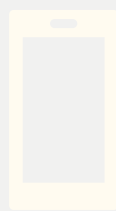

How J is related to K?

- A. Mother
- B. Father
- C. Mother-in-law
- D. Father-in-law
- E. Can't be determined

J, K से किस प्रकार संबंधित है?

- A. माता
- B. पिता
- C. सास
- D. ससुर
- E. निर्धारित नहीं किया जा सकता

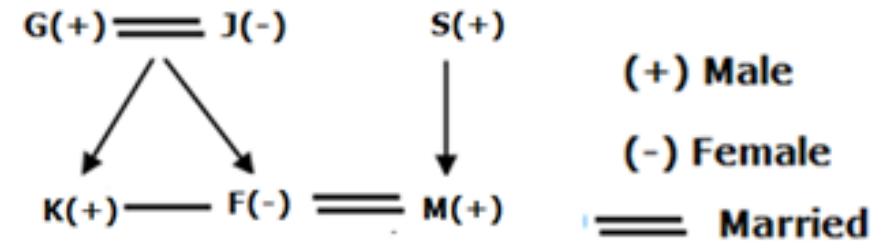



Who among the following persons is the Son-in-law of G?  
निम्नलिखित में से कौन G का दामाद है?

- A. The one who is the brother of F
- B. S
- C. K
- D. The one who is the son of S
- E. None of the above

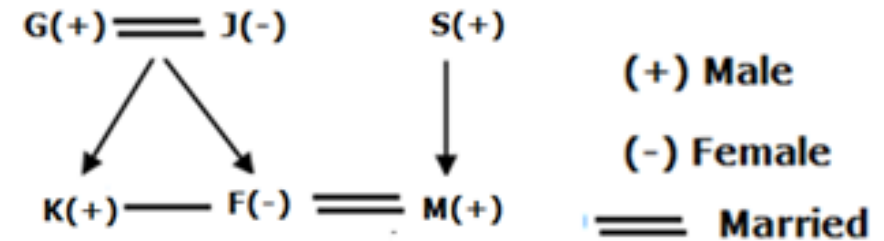

Eight people – G, M, L, R, K, V, J and P were born in different years –1989, 1983, 1995, 1987, 1993, 2000, 1997 and 2002 but not necessarily in the same order. Each person's age calculated with respect to the year (2018), same month and same date. Each one of them likes different colours viz., White, Maroon, Black, Pink, Blue, Red, Green and Purple but not necessarily in the same order. More than three persons were born between the one who likes Red and the one who likes Pink. Two persons were born between L and the one who likes Green. Only one person was born between P and the one who likes Purple. Average age of R and J will be equal to the age of the one who likes Maroon. M's age was one year less than the twice the age of the one who likes Blue. Three persons were born between G and the one who likes Black. G was born before the one who likes Black. R was elder than J. V was 2 years younger than K. The age of the one who likes Pink was an even number. J does not like White. The one who likes Maroon age was not a multiple of 5

आठ व्यक्ति - G, M, L, R, K, V, J और P का जन्म अलग-अलग वर्षों में हुआ था -1989, 1983, 1995, 1987, 1993, 2000, 1997 और 2002 लेकिन आवश्यक नहीं इसी क्रम में हो। प्रत्येक व्यक्ति की आयु की गणना वर्ष (2018), उसी महीने और उसी तिथि के आधार पर की जाती है। उनमें से प्रत्येक को अलग-अलग रंग पसंद हैं जैसे सफेद, लाल, काला, गुलाबी, नीला, लाल, हरा और बैंगनी लेकिन आवश्यक नहीं इसी क्रम में हो।

लाल रंग पसंद करने वाले व्यक्ति और गुलाबी रंग पसंद करने वाले व्यक्ति के मध्य तीन से अधिक व्यक्तियों का जन्म हुआ। L और हरा रंग पसंद करने वाले के बीच दो व्यक्ति पैदा हुए थे। P और बैंगनी रंग पसंद करने वाले के बीच केवल एक व्यक्ति का जन्म हुआ था। R और J की औसत आयु लाल रंग पसंद करने वाले व्यक्ति की आयु के बराबर होगी। M की आयु, नीला रंग पसंद करने वाले व्यक्ति की आयु के दोगुने से एक वर्ष कम थी। G और काला रंग पसंद करने वाले के बीच तीन व्यक्ति पैदा हुए थे। G, काला रंग पसंद करने वाले व्यक्ति से पहले पैदा हुआ था। R, J से बड़ा था। V, K से 2 वर्ष छोटा था। गुलाबी रंग पसंद करने वाले की आयु एक सम संख्या थी। J को सफेद रंग पसंद नहीं है। वह व्यक्ति जिसे मरून पसंद है, वह 5 . का गुणज नहीं है

~~148~~

Eight people – G, M, L, R, K, V, J and P were born in different years – 1989, 1983, 1995, 1987, 1993, 2000, 1997 and 2002 but not necessarily in the same order. Each person's age calculated with respect to the year (2018), same month and same date. Each one of them likes different colours viz., White, Maroon, Black, Pink, Blue, Red, Green and Purple but not necessarily in the same order.

More than three persons were born between the one who likes Red and the one who likes Pink. Two persons were born between L and the one who likes Green. Only one person was born between P and the one who likes Purple. Average age of R and J will be equal to the age of the one who likes Maroon. M's age was one year less than the twice the age of the one who likes Blue. Three persons were born between G and the one who likes Black. G was born before the one who likes Black. R was elder than J. V was 2 years younger than K. The age of the one who likes Pink was an even number. J does not like White. The one who likes Maroon age was not a multiple of 5

Who among the following person likes White?  
निम्नलिखित में से कौन सफेद रंग पसंद करता है?

- A.L  
B.R  
C.K  
D.V  
E. None of these

30

1983	35	M	Purple
1987	31	G	Green
1989	29	P	Red
1993	25	R	White
1995	23	L	Maroon
1997	21	J	Black
2000	18	K	Blue
2002	16	V	Pink

If M is related to White, L is related to Pink, then R is related to which of the following?

यदि M सफेद से संबंधित है, L गुलाबी से संबंधित है, तो R निम्नलिखित में से किससे संबंधित है?

- A. Pink
- B. Black
- C. Blue
- D. Green
- E. None of these

1983	35	M	Purple
1987	31	G	Green
1989	29	P	Red
1993	25	R	White
1995	23	L	Maroon
1997	21	J	Black
2000	18	K	Blue
2002	16	V	Pink



Four of the following five are alike in a certain way and hence they form a group. Which one of the following does not belong to that group?

निम्नलिखित पांच में से चार एक निश्चित तरीके से समान हैं और इसलिए वे एक समूह बनाते हैं। निम्नलिखित में से कौन सा उस समूह से संबंधित नहीं है?

A.M

B.The one who likes Red

C.The one who likes Black

~~D.K~~

E.G

1983	35	M	Purple
1987	31	G	Green
1989	29	P	Red
1993	25	R	White
1995	23	L	Maroon
1997	21	J	Black
2000	18	K	Blue
2002	16	V	Pink





V likes which of the following colour?

V को निम्नलिखित में से कौन सा रंग पसंद है?

A.Red

B.Pink

C.White

D.Blue

E.None of these



1983	35	M	Purple
1987	31	G	Green
1989	29	P	Red
1993	25	R	White
1995	23	L	Maroon
1997	21	J	Black
2000	18	K	Blue
2002	16	V	Pink

What is the age difference between P and the one who likes White (in years)?

P और सफ़ेद रंग पसंद करने वाले व्यक्ति की आयु में कितना अंतर है (वर्षों में)?

A.3

B.2

C.4

D.5

E. None of these

1983	35	M	Purple
1987	31	G	Green
1989	29	P	Red
1993	25	R	White
1995	23	L	Maroon
1997	21	J	Black
2000	18	K	Blue
2002	16	V	Pink

30

If a four letter meaningful word can be formed by using the second, fourth, sixth and seventh letters of the word "JORNAL" then what is the second letter from the left end of the newly formed word? Mark X as your answer if more than one word is formed. Mark Z if no meaningful word can be formed.

यदि शब्द "जर्नल" के दूसरे, चौथे, छठे और सातवें अक्षरों का उपयोग करके चार अक्षर का अर्थपूर्ण शब्द बनाया जा सकता है तो नए बने शब्द के बाएं छोर से दूसरा अक्षर क्या है? यदि एक से अधिक शब्द बनते हैं तो X को अपने उत्तर के रूप में चिह्नित करें। यदि कोई सार्थक शब्द नहीं बनाया जा सकता है तो Z पर निशान लगाएँ।

- A.R
- B.A
- C.L
- D.X
- E.Z

~~ORAL~~

30

Study the following information carefully and answer the below questions  
 Point X is 20km north of point M which is 5km west of point G.  
 Point Z is 15km east of point P which is 7km west of R. Point Y  
 is north of R and East of Point X. point P 28km south of point G.

बिंदु X, बिंदु M के 20 किमी उत्तर में है जो बिंदु G के 5 किमी पश्चिम में है। बिंदु Z,  
 बिंदु P के 15 किमी पूर्व में है जो R के 7 किमी पश्चिम में है। बिंदु Y, R के उत्तर में  
 और बिंदु X के पूर्व में है। बिंदु P, बिंदु G के 28 किमी दक्षिण में है। .

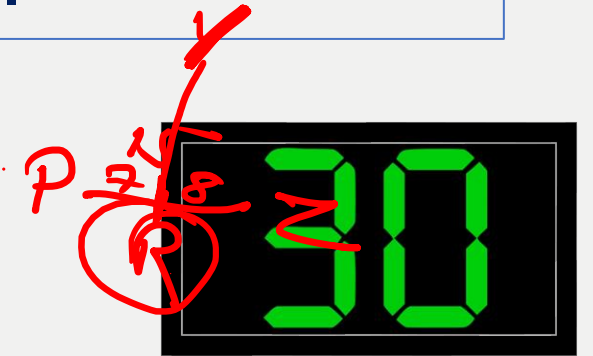
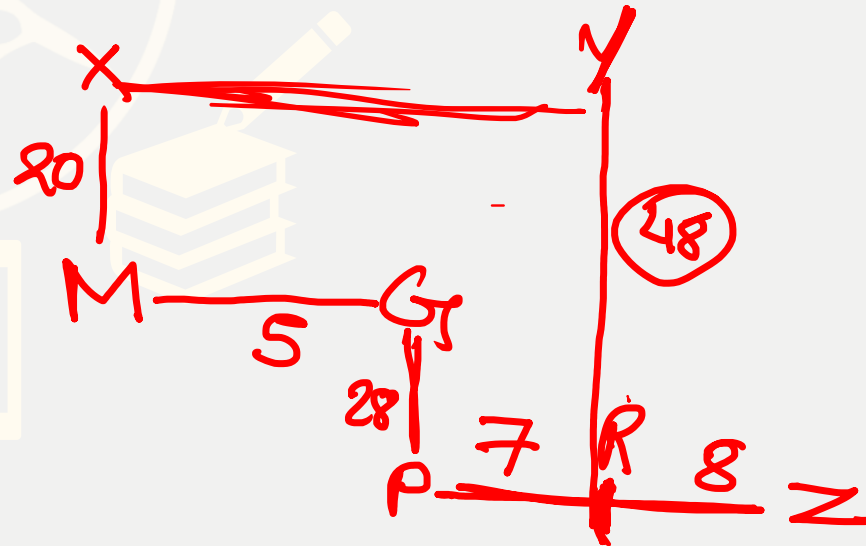

What is the direction of point G with respect to point R?

बिंदु R के सन्दर्भ में बिंदु G की दिशा क्या है?

- A. East
- B. West
- C. North-west
- D. South
- E. South-west

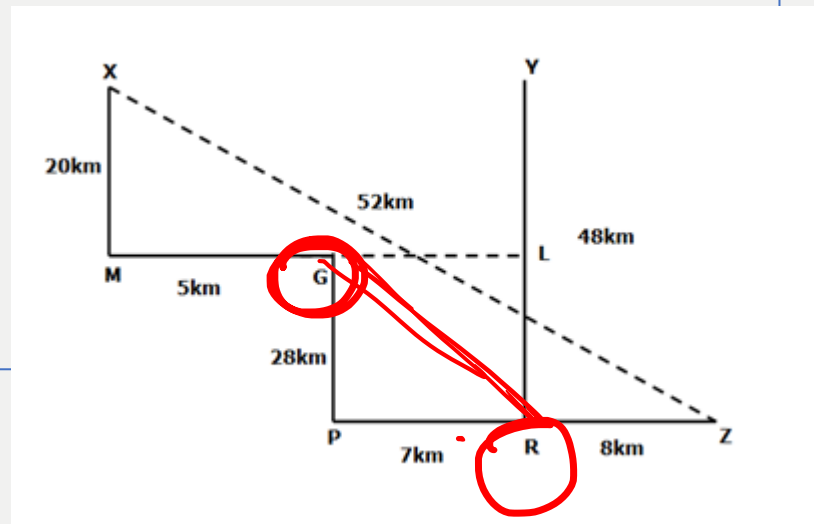

What is the shortest distance between Points Z and X?

बिंदु Z और X के बीच न्यूनतम दूरी क्या है?

A. 48 km

B. 42 km

C. 58 km

D. 52 km

E. Can't be determined

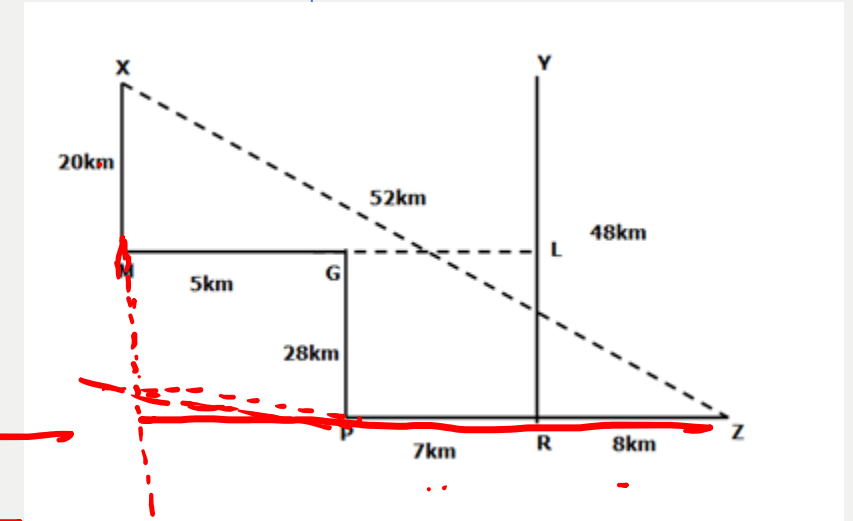

$$\sqrt{48^2 + 20^2}$$

30

If Point L lies between the points Y and R and is to the east of Point G, then what is the distance between the points L and M?

यदि बिंदु L, बिंदु Y और R के बीच स्थित है और बिंदु G के पूर्व में है, तो बिंदु L और M के बीच की दूरी क्या है?

- A. 22km
- B. 20km
- C. 15km
- D. 10km
- ~~E. 12km~~

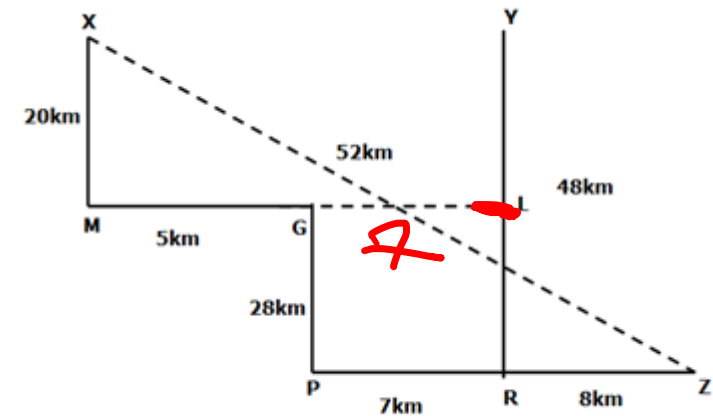



**Statement:**

$$P \leq Y \geq J ; L = U < O ; I > L \leq G = Y$$

**Conclusion:**

- ~~I).  $O > I$~~
- ~~II).  $G \geq J$~~
- ~~III).  $U = Y$~~

$$\underline{O > L < I}$$

$$G = Y \geq J$$

- A. Only I follows
- ~~B. Only II follows~~
- C. Only III follows
- D. All follow
- E. None follows



30

**Statement:**
$$M < S < A < C; \quad O \geq C = T \geq B; \quad K \geq L > T > V$$
**Conclusion:**

- ~~I).  $K = B$~~
- ~~II).  $A < L$~~
- ~~III).  $K > B$~~

$$K > T > B$$
$$A < C = T < L$$

- A. Only II follows
- B. Only III follows
- ~~C. Both II and III follow~~
- D. Only II and either I or III follow
- E. None follows

A man from point A walks towards west for 3m and turns to his left at point B, from where he walks for 1m and reaches point C. Then, he turns to his right and walks for 6m to reach point D where he turns to his left. Then he walks for 8m and reaches point E. He walks for 2m after taking a left turn and reaches point F. Then he walks for 4m towards the north to reach point G from where he turns to his right and walks for 7m to reach point H.

एक व्यक्ति बिंदु A से पश्चिम की ओर 3मी चलता है और बिंदु B पर अपनी बाईं ओर मुड़ता है, जहां से वह 1मी चलता है और बिंदु C पर पहुंचता है। फिर, वह अपनी दाईं ओर मुड़ता है और बिंदु D पर पहुंचने के लिए 6मी चलता है, जहां वह अपनी ओर मुड़ता है बाएं। फिर वह 8 मीटर चलता है और बिंदु E पर पहुंचता है। वह बाएं मुड़ने के बाद 2 मीटर चलता है और बिंदु F पर पहुंचता है। फिर वह बिंदु G पर पहुंचने के लिए उत्तर की ओर 4 मीटर चलता है, जहां से वह अपनी दाईं ओर मुड़ता है और एच बिंदु पर पहुंचने के लिए 7 मीटर चलता है।

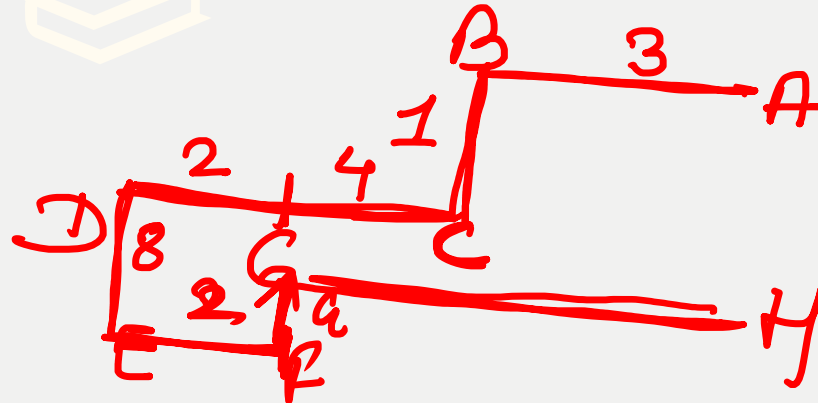

What is the shortest distance between points A and H?

बिंदु A और H के बीच न्यूनतम दूरी क्या है?

A. 6m

B. 8m

C. 7m

D. 5m

E. None of these

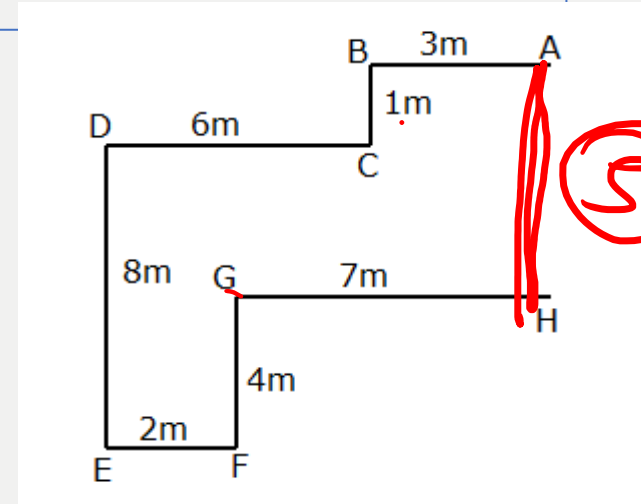

In what direction is point D with respect to point G?

बिंदु G के सन्दर्भ में बिंदु D किस दिशा में है?

- A. North
- B. Southeast
- C. Northwest
- D. South
- E. None of these

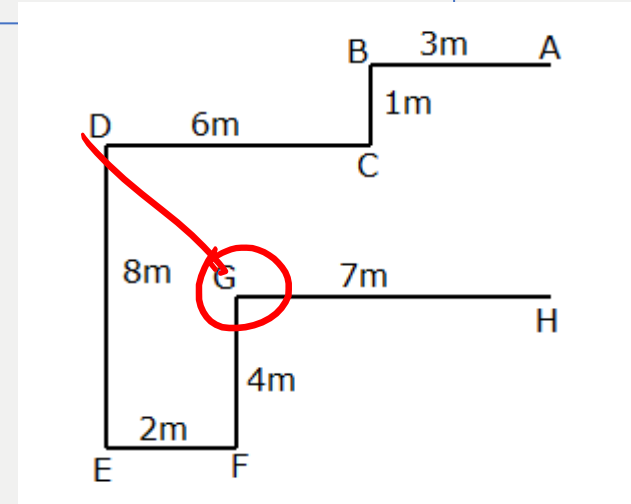

What is the approximate shortest distance between points E and B?  
 बिंदु E और B के बीच लगभग न्यूनतम दूरी कितनी है?

- A. 12m
- ~~B. 11m~~
- C. 10m
- D. 13m
- E. None of these

$$\sqrt{81736}$$

$$\sqrt{117}$$

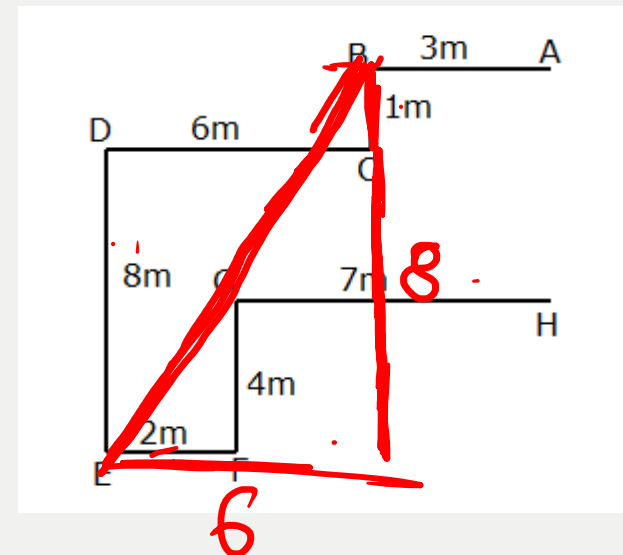
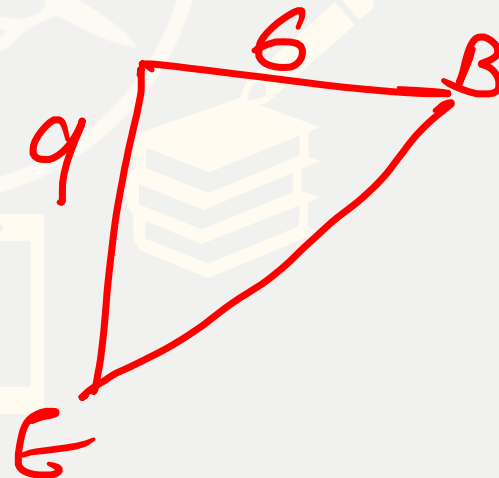

Letters	J	P	B	O	S	M	U	E	G	Z	T	A	I	R
Codes	2	^	9	Δ	¥	¢	6	3	~	€	7	\$	1	π

**Conditions:**

- I) If the 1<sup>st</sup> letter is followed by a vowel and the last letter is a consonant, the codes of both of these letters (V&C) are to be interchanged.
- II) If both the 1<sup>st</sup> and the 2<sup>nd</sup> last letters are vowels then both of these letters are to be coded as €.
- III) If the 1<sup>st</sup> letter is a consonant and last letter is a vowel then both of these letters are to be coded as per the code of the last letter.

EMPIUB  
 € ¢ ^ 1€9

II EMPIUB

- A. 3¢ ^ 139
- B. 6¢ 1 ^ 39
- C. € ¢ ^ 16€
- D. ~~€ ¢ ^ 1€9~~
- E. 9¢ ^ 16€





Letters	J	P	B	O	S	M	U	E	G	Z	T	A	I	R
Codes	2	^	9	Δ	¥	¢	6	3	~	€	7	\$	1	π

**Conditions:**

- I) If the 1<sup>st</sup> letter is followed by a vowel and the last letter is a consonant, the codes of both of these letters (V&C) are to be interchanged.
- II) If both the 1<sup>st</sup> and the 2<sup>nd</sup> last letters are vowels then both of these letters are to be coded as €.x
- III) If the 1<sup>st</sup> letter is a consonant and last letter is a vowel then both of these letters are to be coded as per the code of the last letter.

**TROGSZ**

- ~~A. €πΔ~¥7~~
- ~~B. €πΔ¥~7~~
- ~~C. 7πΔ~¥€~~
- D. 7πΔ~€¥
- ~~E. 7π~Δ¥€~~



Letters	J	P	B	O	S	M	U	E	G	Z	T	A	I	R
Codes	2	^	9	Δ	¥	¢	6	3	~	€	7	\$	1	π

**Conditions:**

- I) If the 1<sup>st</sup> letter is followed by a vowel and the last letter is a consonant, the codes of both of these letters (V&C) are to be interchanged.
- II) If both the 1<sup>st</sup> and the 2<sup>nd</sup> last letters are vowels then both of these letters are to be coded as €.x
- III) If the 1<sup>st</sup> letter is a consonant and last letter is a vowel then both of these letters are to be coded as per the code of the last letter.

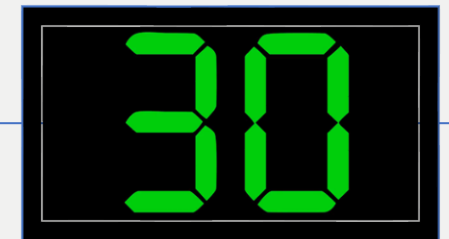

**SAGMJR**

- A. π¥~¢2\$
- B. π\$~¢2¥
- C. ¥π~¢2¥
- D. ¥\$~¢2π
- E. ¥π~¢2\$

Letters	J	P	B	O	S	M	U	E	G	Z	T	A	I	R
Codes	2	^	9	Δ	¥	¢	6	3	~	€	7	\$	1	π

**Conditions:**

- I) If the 1<sup>st</sup> letter is followed by a vowel and the last letter is a consonant, the codes of both of these letters (V&C) are to be interchanged.
- II) If both the 1<sup>st</sup> and the 2<sup>nd</sup> last letters are vowels then both of these letters are to be coded as €.x
- III) If the 1<sup>st</sup> letter is a consonant and last letter is a vowel then both of these letters are to be coded as per the code of the last letter.

PTSOZI

- A. 17¥Δ€1
- B. 17¥Δ21
- C. ^7¥Δ€1
- D. 17¥Δ€7
- E. ^7¥Δ1€

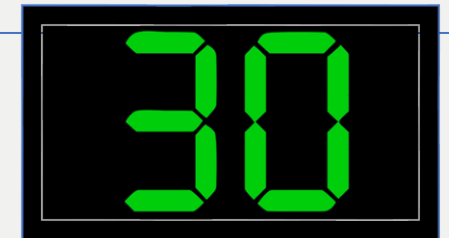

There are eight people P, Q, R, S, T, U, V, and W live on eight different floors of the building but not necessarily in the same order. The lowermost floor is numbered as 1 and the topmost floor is numbered as 8.

S lives on an odd numbered floor but above the floor number 4. R lives two floors below the one who lives immediately below U. More than three floors are between Q and V. The number of persons lives above T is one more than the numbers of persons lives below S. W lives adjacent floor of neither V nor T. U lives two floors above V. Q lives immediately above S.

आठ व्यक्ति P, Q, R, S, T, U, V और W इमारत की आठ अलग-अलग मंजिलों पर रहते हैं लेकिन जरूरी नहीं कि इसी क्रम में हों। सबसे निचली मंजिल की संख्या 1 और सबसे ऊपरी मंजिल की संख्या 8 है।

S एक विषम संख्या वाली मंजिल पर रहता है लेकिन मंजिल संख्या 4 के ऊपर रहता है। R, U के ठीक नीचे रहने वाले व्यक्ति के नीचे दो मंजिलों पर रहता है। Q और V के बीच तीन से अधिक मंजिलें हैं। T के ऊपर रहने वाले व्यक्तियों की संख्या संख्याओं से एक अधिक है। व्यक्तियों की संख्या S के नीचे रहती है। W न तो V और न ही T के आसन्न मंजिल पर रहता है। U, V से दो मंजिल ऊपर रहता है। Q, S के ठीक ऊपर रहता है।



**There are eight people P, Q, R, S, T, U, V, and W live on eight different floors of the building but not necessarily in the same order. The lowermost floor is numbered as 1 and the topmost floor is numbered as 8.**

**S lives on an odd numbered floor but above the floor number 4. R lives two floors below the one who lives immediately below U. More than three floors are between Q and V. The number of persons lives above T is one more than the numbers of persons lives below S. W lives adjacent floor of neither V nor T. U lives two floors above V. Q lives immediately above S.**

Who among the following person lives three floors above P?  
निम्नलिखित में से कौन P से तीन मंजिल ऊपर रहता है?

- a) The one who lives immediately above W
- b) U
- c) The one who lives two floors below V
- d) R
- e) None of these



Floor	Persons
8	Q
7	S
6	W
5	U
4	P
3	V
2	R
1	T

What is the position of S from the top of the building?  
इमारत के ऊपर से S का स्थान क्या है?

- a) Third
- b) Fourth
- c) Sixth
- d) Fifth
- e) Second



Floor	Persons
8	Q
7	S
6	W
5	U
4	P
3	V
2	R
1	T



How many floors are between W and R?

W और R के मध्य कितनी मंजिलें हैं?

- a) Same as between Q and P
- b) Same as between T and U
- c) Three
- d) Same as between V and S.
- e) All of the above



Floor	Persons
8	Q
7	S
6	W
5	U
4	P
3	V
2	R
1	T

Four of the following five are alike in a certain way and hence form a group. Who among the following one does not belong to the group?

निम्नलिखित पांच में से चार एक निश्चित तरीके से समान हैं और इसलिए एक समूह बनाते हैं। निम्नलिखित में से कौन समूह से संबंधित नहीं है?

- a) Q
- b) W
- c) U
- d) R
- e) P



Floor	Persons
8	Q
7	S
6	W
5	U
4	P
3	V
2	R
1	T

Which of the following statement(s) is/are true with respect to T?

- I) T lives on the lowermost floor
- II) Only one floor between T and V
- III) T lives immediately below R

T के संबंध में निम्नलिखित में से कौन सा/से कथन सत्य है/हैं?

- I) T सबसे निचली मंजिल पर रहता है
- II) T और V के बीच केवल एक मंजिल
- III) T, R . के ठीक नीचे रहता है

- a) Both I and III
- b) Only III
- c) Both I and II
- d) All I, II and III
- e) None of these

Floor	Persons
8	Q
7	S
6	W
5	U
4	P
3	V
2	R
1	T



30

**Study the given information carefully and answer the following questions.**

@ Means either the hour hand or the minute hand of the clock is at 2

& Means either the hour hand or the minute hand of the clock is at 7

\$ Means either the hour hand or the minute hand of the clock is at 5

% Means either the hour hand or the minute hand of the clock is at 8

\* Means either the hour hand or the minute hand of the clock is at 4

# Means either the hour hand or the minute hand of the clock is at 9

! Means either the hour hand or the minute hand of the clock is at 3



***Note: The first symbol represents the hour hand and the second symbol represents the Minute hand. All the given time is considered only in PM unless otherwise mentioned. For example: @# means 2.45PM.***

**Study the given information carefully and answer the following questions.**

- @ Means either the hour hand or the minute hand of the clock is at 2
- & Means either the hour hand or the minute hand of the clock is at 7
- \$ Means either the hour hand or the minute hand of the clock is at 5
- % Means either the hour hand or the minute hand of the clock is at 8
- \* Means either the hour hand or the minute hand of the clock is at 4
- # Means either the hour hand or the minute hand of the clock is at 9
- ! Means either the hour hand or the minute hand of the clock is at 3



**If a person has an interview at \$#. He takes 45 minutes travel to reach the interview venue from railway station and the same person take 35 minutes to reach railway station from his House. Then, when should the person depart from his house to reach the interview venue by 40 minutes before from his interview time?**

अगर किसी व्यक्ति का इंटरव्यू \$# पर है। वह रेलवे स्टेशन से साक्षात्कार स्थल तक पहुंचने में 45 मिनट का समय लेता है और वही व्यक्ति अपने घर से रेलवे स्टेशन पहुंचने में 35 मिनट का समय लेता है। तो, साक्षात्कार के समय से 40 मिनट पहले साक्षात्कार स्थल पर पहुंचने के लिए व्यक्ति को अपने घर से कब प्रस्थान करना चाहिए?

- A) None of these
- B) &!
- C) !#
- D) !\*
- E) \$!

**Study the given information carefully and answer the following questions.**

@ Means either the hour hand or the minute hand of the clock is at 2

& Means either the hour hand or the minute hand of the clock is at 7

\$ Means either the hour hand or the minute hand of the clock is at 5

% Means either the hour hand or the minute hand of the clock is at 8

\* Means either the hour hand or the minute hand of the clock is at 4

# Means either the hour hand or the minute hand of the clock is at 9

! Means either the hour hand or the minute hand of the clock is at 3



**Nila walks at 20km speed per hour. She starts walking from point A at %@ and covers a distance of 30km to reach point B. then when will Nila reach at point B?**

**नीला 20 किमी प्रति घंटे की गति से चलती है। वह बिंदु A से %@ पर चलना शुरू करती है और बिंदु B तक पहुंचने के लिए 30 किमी की दूरी तय करती है। नीला बिंदु B पर कब पहुंचेगा?**

- A) \*%
- B) %\*
- C) #\*
- D) None of these
- E) #%

**Study the given information carefully and answer the following questions.**

- @ Means either the hour hand or the minute hand of the clock is at 2
- & Means either the hour hand or the minute hand of the clock is at 7
- \$ Means either the hour hand or the minute hand of the clock is at 5
- % Means either the hour hand or the minute hand of the clock is at 8
- \* Means either the hour hand or the minute hand of the clock is at 4
- # Means either the hour hand or the minute hand of the clock is at 9
- ! Means either the hour hand or the minute hand of the clock is at 3



**J departed from Singapore on Monday \*!. The flight took 17 hours to reach Chennai airport. She went to meet his old friend at Madurai where her friend has arrived 3 hours earlier to J. J took 8 hours to reach Madurai from Chennai via train. Then when was J's friend arrived at their meeting place?**

**जाहनवी सोमवार को सिंगापुर से रवाना हुई\*!. फ्लाइट को चेन्नई एयरपोर्ट पहुंचने में 17 घंटे लगे। वह मदुरै में अपने पुराने दोस्त से मिलने गई, जहां उसका दोस्त 3 घंटे पहले जानू आया है। जानू को चेन्नई से ट्रेन के जरिए मदुरै पहुंचने में 8 घंटे लगे। तब जानू का मित्र उनके मिलन स्थल पर कब पहुँचा?**

- A) @!
- B) !!
- C) \*!
- D) @%
- E) None of these



**1) Answer: C**

•A person has an interview at  $5:45\text{pm}$

•He takes 45 minutes travel to reach interview venue from railway station, and the same person takes 35 minutes to reach railway station from his House so if the person departs at  $3:45\text{pm}$  from his house then he reached  $4:20\text{pm}$  at railway station and then he reach  $5:05\text{pm}$  at interview venue which is 40 minutes before his actual interview time. So  $3:45\text{pm} - 1\text{hr} - 35\text{min}$  - so option "C" answer.

**2) Answer: E**

Nila starts walking from point A at  $8:10\text{pm}$

Time taken to cover the distance =  $30\text{km}/20\text{km per hr} = 1.5\text{hr}$

$1.5\text{ hr}$  she takes to cover the distance,  $8:10\text{ pm} + 1.5\text{hr}$ (i.e.,  $1\text{hr } 30\text{ minutes}$ ) =  $9:40\text{pm}$

**3) Answer: A**

Janu departed from Singapore on Monday  $4:15\text{pm}$

The flight took 17 hours to reach Chennai airport -  $4:15\text{pm} + 17\text{ hrs} = 9:15\text{am}$  on Tuesday.

Janu took 8 hours to reach Madurai from Chennai via train =  $9:15\text{am} + 8\text{hours} = 5:15\text{pm}$  on Tuesday

Her friend arrived 3hours earlier to Janu-  $5:15\text{ pm} - 3\text{hr} = 2:15\text{ pm} = 2:15\text{ pm}$

2:00

FOR MORE DISCOUNT VISIT [www.mahendras.org](http://www.mahendras.org) & USE PROMO CODE : **E14727**

Study the following information carefully and answer the below questions.

There are seven family members A, B, M, N, O, Y and Z. There are two married couples. B is the brother-in-law of Y and son of M. Z is the sister-in-law of A. M is the grandfather of N. O is the brother of N. M has two children and only one son. Z is the mother of N, who is the niece of A. A is the wife of Y.

परिवार के सात सदस्य A, B, M, N, O, Y और Z हैं। दो विवाहित जोड़े हैं। B, Y का साला है और M का बेटा है। Z, A की साली है। M, N का दादा है। O, N का भाई है। M के दो बच्चे हैं और केवल एक बेटा है। Z, N की माता है, जो A की भतीजी है। A, Y की पत्नी है।

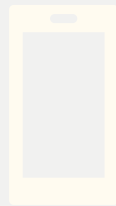

How is A related to N?

A, N से किस प्रकार संबंधित है?

- A) Aunt
- B) Mother
- C) Mother-in-law
- D) Sister
- E) Sister-in-law

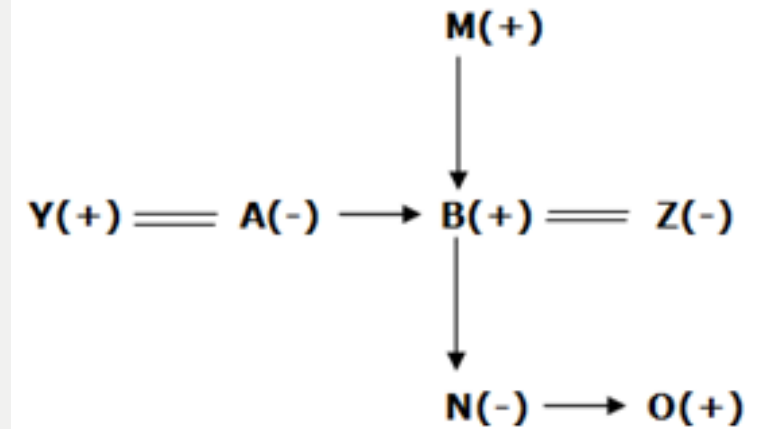

If G is the son of A then how is G related to M?

यदि G, A का पुत्र है, तो G, M से किस प्रकार संबंधित है?

- A) Daughter
- B) Son
- C) Grandson
- D) Father
- E) None of these

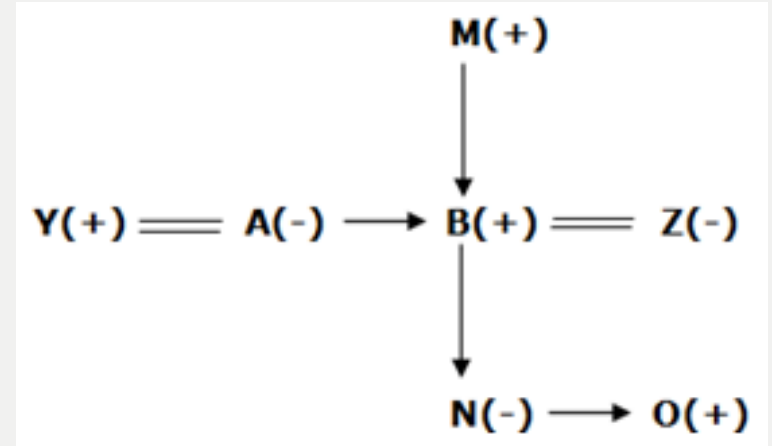

If it is possible to make a three letter meaningful word by using the third, fourth, and seventh letters of the word "CURIOUS", then How many words can be formed?

यदि शब्द "CURIOUS" के तीसरे, चौथे और सातवें अक्षरों का उपयोग करके तीन अक्षरों का अर्थपूर्ण शब्द बनाना संभव है, तो कितने शब्द बन सकते हैं?

- a) One
- b) Two
- c) Three
- d) More than three
- e) None





Eight members of a family namely – B, D, G, H, P, Q, R and W are sitting in a row in such a way that some are facing north while some are facing south but not necessarily in the same order.

B is a male. H's wife sits three places to the left of Q, who neither sits adjacent to R nor sits adjacent to P. Q is the only son of D and is an unmarried member of the family. P sits four places to the right of H, who is the father of R. Neither P nor H sits at the end of the row. The number of persons sits between H and D is two more than the number of persons sits between Q and B. Q is the son of R's brother. G's father-in-law sits third to the left of G, who sits facing south. B neither sits adjacent to H nor sits at the end of the row. R sits fourth to the right of B, who sits facing south. B is married to D. At least two persons sit between H and H's wife. Persons at the end of the row sit facing in opposite directions to each other. P is neither a male member nor married to G. The persons adjacent to B sit facing in opposite direction to each other. G's wife sits second to the right of Q and is the daughter of D. W's grandfather sits on the immediate right of W. P's daughter and P sits facing in the same direction.

निम्नलिखित जानकारी का ध्यानपूर्वक अध्ययन करें और नीचे दिए गए प्रश्नों के उत्तर दें।  
एक परिवार के आठ सदस्य अर्थात् - B, D, G, H, P, Q, R और W एक पंक्ति में इस प्रकार बैठे हैं कि कुछ का मुख उत्तर की ओर है जबकि कुछ का मुख दक्षिण की ओर है लेकिन आवश्यक नहीं कि इसी क्रम में हों।  
बी पुरुष है। H की पत्नी, Q के बायें से तीन स्थान पर बैठी है, जो न तो R के आसन्न बैठा है और न ही P के आसन्न बैठा है। Q, D का इकलौता पुत्र है और परिवार का एक अविवाहित सदस्य है। P, H के दायें चार स्थान पर बैठा है, जो R का पिता है। न तो P और न ही H पंक्ति के अंत में बैठा है। H और D के बीच बैठे व्यक्तियों की संख्या Q और B के बीच बैठे व्यक्तियों की संख्या से दो अधिक है। Q, R के भाई का पुत्र है। G के ससुर, G के बायें से तीसरे स्थान पर बैठे हैं, जो दक्षिण की ओर मुख करके बैठा है। B न तो H के आसन्न बैठा है और न ही पंक्ति के अंत में बैठा है। R, B के दायें से चौथे स्थान पर बैठा है, जो दक्षिण की ओर मुख करके बैठा है। B, D से विवाहित है। H और H की पत्नी के बीच कम से कम दो व्यक्ति बैठे हैं। पंक्ति के अंत में व्यक्ति एक दूसरे के विपरीत दिशा में उन्मुख होकर बैठते हैं। P न तो पुरुष सदस्य है और न ही G से विवाहित है। B के आसन्न व्यक्ति एक दूसरे के विपरीत दिशा में उन्मुख होकर बैठे हैं। G की पत्नी Q के दायें से दूसरे स्थान पर बैठी है और D की पुत्री है। W के दादा, W के ठीक दायें बैठे हैं। P की बेटी और P समान दिशा की ओर उन्मुख होकर बैठे हैं।

What is the position of G's brother-in-law with respect to D?

**D के सन्दर्भ में G के ब्रदर-इन-लॉ का स्थान क्या है?**

- A. Second to the right**
- B. Third to the left**
- C. Immediate right**
- D. Second to the left**
- E. None of these**

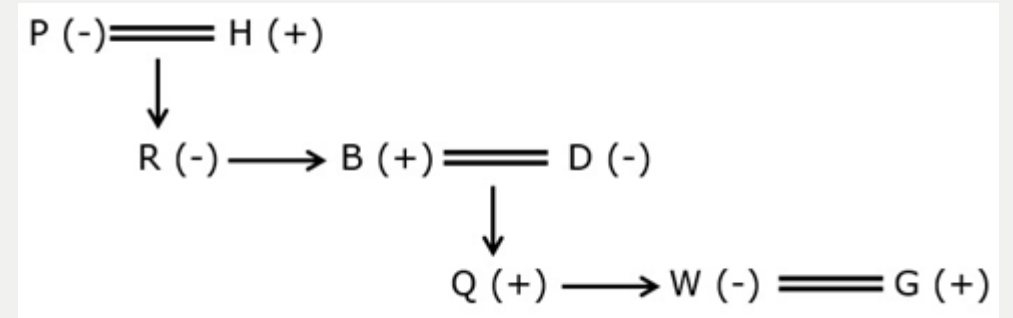
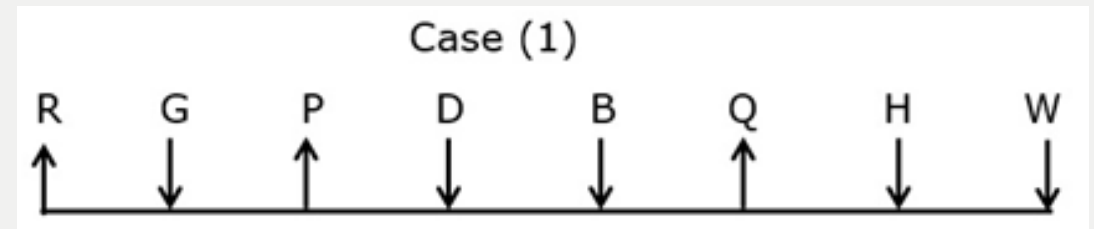



How is P related to B?

P, B से किस प्रकार संबंधित है?

A.Mother

B.Maternal Aunty

C.Father-in-law

D.Grandfather

E.None of these

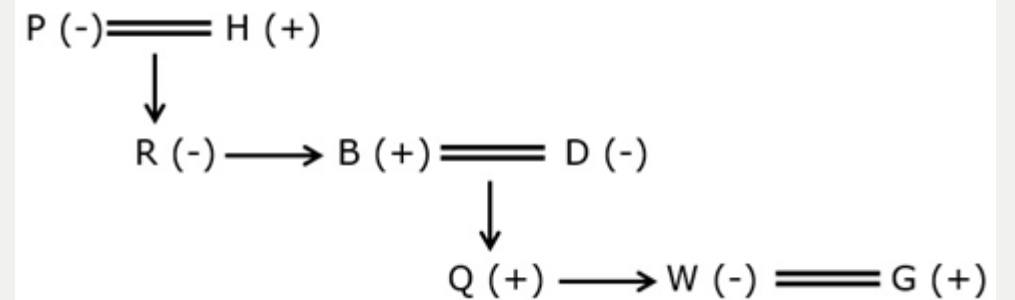
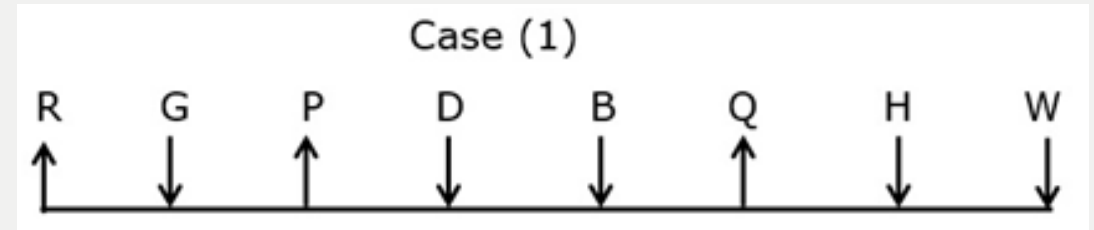

Which of the following pair sits at the end of the row?

निम्नलिखित में से कौन सा जोड़ा पंक्ति के अंत में बैठा है?

A. W & G

B. P & R

C. R & W

D. Q & W

E. None of these

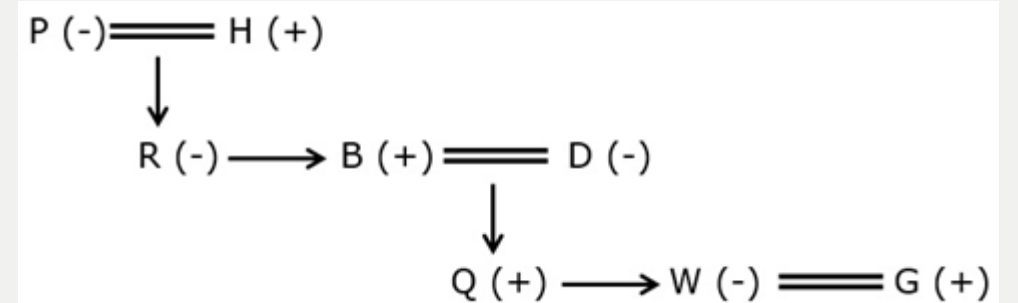
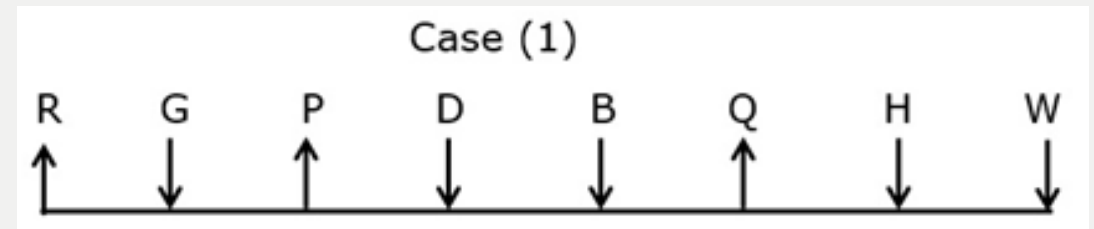

Which of the following statement is not true?

निम्नलिखित में से कौन सा कथन सत्य नहीं है?



- A. W sits third to the left of W's father.
- B. The one who is the daughter of P sits on the immediate right of G.
- C. H sits on the immediate right of Q.
- D. W's husband sits on the immediate left of P.
- E. All the above statements are true.

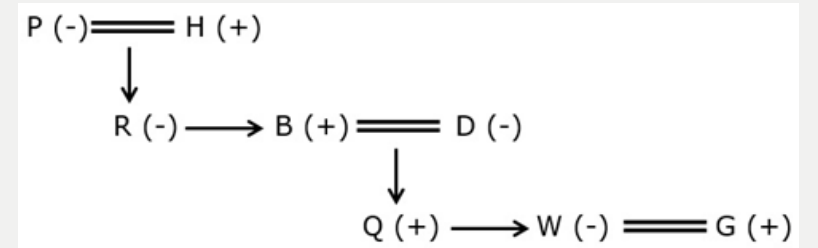
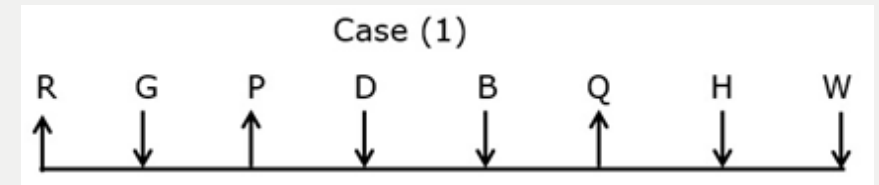

**Statements:**  $H \geq O = U \geq B < L = P; D < N = B \geq S > K$

**Conclusions:**

I.  $K < L$

II.  $H \geq K$

A) only I follows

B) only II follows

C) either I or II follows

D) neither I nor II follow

E) both I and II follow

 30

**Statements:**  $B < N = T \geq G > H = F$ ;  $G > L = D > V$ ;  $L > W = A$

**Conclusions:**

I.  $A < H$

II.  $V < B$

A) only I follows

B) only II follows

C) either I or II follows

D) neither I nor II follow

E) both I and II follow



30

**Statements:**  $F \geq V = T \geq G < L \leq D = S$ ;  $E = Q < T \leq N$ ;  $Q > P = W$

**Conclusions:**

I.  $D > N$

II.  $F > W$

A) only I follows

B) only II follows

C) either I or II follows

D) neither I nor II follow

E) both I and II follow

 30

Eight family members of three generations are as follows. T has a sister O. M is the father of A who is the wife of D. B is A's son. C is the son of D. N who has no sibling, is the brother-in-law of T. D is the son-in-law of T.

तीन पीढ़ियों के परिवार के आठ सदस्य इस प्रकार हैं। T की एक बहन O है। M, A का पिता है जो D की पत्नी है। B, A का पुत्र है। C, D का पुत्र है। N जिसका कोई सहोदर नहीं है, वह T का साला है। D, T का दामाद है।

**How is O related to M?**

- A) Sister
- B) Wife
- C) Niece
- D) Sister-in-law
- E) Mother

**O, M से किस प्रकार संबंधित है?**

- A. बहन
- B. पत्नी
- C. भतीजी
- D. भाभी
- E. माँ

M(+) == T(-) — O(-) == N(+)  
|  
A(-) == D(+)  
|  
B(+) — C(+)



If N has a daughter P, then how P is related to A?

- A) Sister
- B) Cousin
- C) Niece
- D) Brother
- E) Nephew

यदि N की एक पुत्री P है, तो P, A से किस प्रकार संबंधित है?

- A. बहन
- B. चचेरा भाई
- C. भतीजी
- D. भाई
- E. भतीजा



30

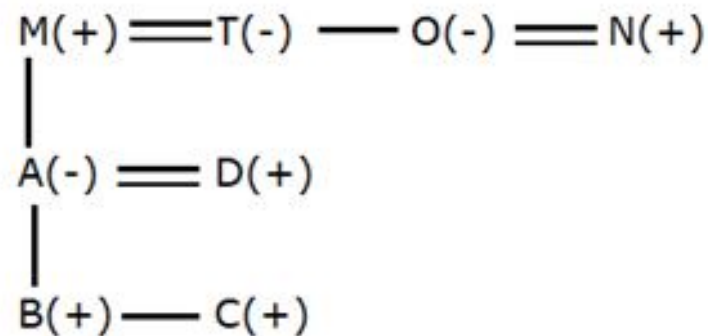



How is B related to C?

**B, C से किस प्रकार संबंधित है?**

- A) Sister**
- B) Cousin**
- C) Niece**
- D) Brother**
- E) Nephew**

M(+) == T(-) — O(-) == N(+)  
|  
A(-) == D(+)  
|  
B(+) — C(+)

**Study the following information carefully and answer the questions given below.**

Five students P, Q, R, S and T are written exams and got different marks in the examination. P scored more marks than Q but less than R, who scored 65 marks. S scored less marks than only T. The one who scored the minimum marks scored 60 marks and the one who scored the maximum marks scored 80 marks.

निम्नलिखित जानकारी का ध्यानपूर्वक अध्ययन करें और नीचे दिए गए प्रश्नों के उत्तर दें।

पांच छात्र P, Q, R, S और T लिखित परीक्षा में हैं और उन्होंने परीक्षा में अलग-अलग अंक प्राप्त किए हैं। P ने Q से अधिक अंक प्राप्त किए लेकिन R से कम अंक प्राप्त किए, जिसने 65 अंक प्राप्त किए। S ने केवल T से कम अंक प्राप्त किए। न्यूनतम अंक प्राप्त करने वाले ने 60 अंक प्राप्त किए और अधिकतम अंक प्राप्त करने वाले ने 80 अंक प्राप्त किए।

30

**Who scored the second-highest marks?**

**दूसरा सबसे अधिक अंक किसने प्राप्त किया?**

- A) P
- B) Q
- C) R
- D) S
- E) T

30

**Who is most likely to have scored 62 marks?**

**62 अंक प्राप्त करने की सबसे अधिक संभावना कौन है?**

- A) R
- B) P
- C) S
- D) Q
- E) T

Who scored the lowest marks?  
सबसे कम अंक किसने प्राप्त किए?

- A) R
- B) P
- C) Q
- D) T
- E) S

30

Person	Marks
T	80
S	
R	65
P	
Q	60

If it is possible to make only one meaningful word with the 1st, 3rd, 5th and 7th letters of the word 'MATHEMATICS' which would be the second letter of the word from the right end? If more than one such word can be formed give 'X' as the answer. If no such word can be formed, give 'Z' as your answer.

यदि शब्द 'MATHEMATICS' के पहले, तीसरे, पांचवें और सातवें अक्षरों से केवल एक अर्थपूर्ण शब्द बनाना संभव है, तो दायें छोर से शब्द का दूसरा अक्षर कौन सा होगा? यदि ऐसे एक से अधिक शब्द बन सकते हैं तो उत्तर 'X' दें। यदि ऐसा कोई शब्द नहीं बनाया जा सकता है, तो अपना उत्तर 'Z' दें।

- A) X
- B) E
- C) M
- D) Z
- E) T



Study the following information carefully and answer the below questions.

**Point E is 3m south-west from point D. Point H is 10m east from point E. Point G is 5m south of point F. Point G and point I are in the straight line. The point I was south of point H. Point F is south of point D and in the straight line between points E and H. Point H is 6m east of Point F.**

बिंदु E, बिंदु D से 3मी दक्षिण-पश्चिम में है। बिंदु H, बिंदु E से 10मी पूर्व में है। बिंदु G, बिंदु F के 5मी दक्षिण में है। बिंदु G और बिंदु I एक सीधी रेखा में हैं। बिंदु I, बिंदु H के दक्षिण में था। बिंदु F, बिंदु D के दक्षिण में है और बिंदु E और H के बीच की सीधी रेखा में है। बिंदु H, बिंदु F के 6मी पूर्व में है।



What is the shortest distance between point D and point F?

बिंदु D और बिंदु F के बीच न्यूनतम दूरी क्या है?

7m

5m

3m

4m

None of these

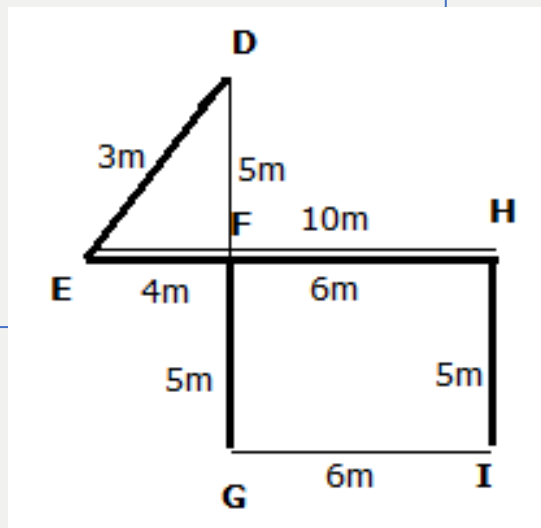

What is the shortest distance between from point E to point I?

बिंदु E से बिंदु I के बीच न्यूनतम दूरी क्या है?

- A) 12m
- B) 15m
- C) 16m
- D) Cannot be determined
- E) None of these

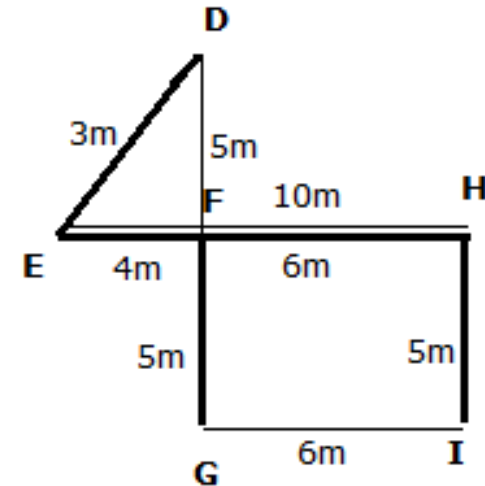

30

